

# A Dynamic Recursive Structure for Intelligent Inspection

Tarek M. Sobh, Mohamed Dekhil, Chris Jaynes, and Thomas C. Henderson<sup>1</sup>

UUCS-92-036

Department of Computer Science  
University of Utah  
Salt Lake City, UT 84112 USA

October 26, 1992

## Abstract

We suggest a new approach for inspection and reverse engineering applications. In particular, we investigate the use of discrete event dynamic systems (DEDS) to guide and control the active exploration and sensing of mechanical parts for industrial inspection and reverse engineering. We introduce dynamic recursive finite state machines (DRFSM) as a new DEDS tool for utilizing the recursive nature of the mechanical parts under consideration. The proposed framework uses DRFSM DEDS for constructing an observer for exploration and inspection purposes.

---

<sup>1</sup>This work was supported in part by DARPA grant N00014-91-J-4123 and NSF grant CDA 9024721. All opinions, findings, conclusions or recommendations expressed in this document are those of the author and do not necessarily reflect the views of the sponsoring agencies.

# 1 Introduction

Developing environments for inspection and reverse engineering applications is an essential activity in many engineering disciplines. Usually, too much time is spent in designing hardware and software environments, in order to be able to attack a specific problem.

One of the purposes of this work is to provide a basis for solving a class of inspection and reverse engineering problems. The technique to be explored can hopefully be used for a variety of applications. We use an observer agent to sense the current world environment and make some measurements, then supply relevant information to a control module that will be able to make some design choices that will later affect manufacturing and/or inspection activities. This involves both autonomous and semi-autonomous sensing.

We use a recursive dynamic strategy for exploring machine parts. A discrete event dynamic system (DEDS) framework is designed for modeling and structuring the sensing and control problems. Next, we discuss the objectives and research questions, then we discuss the DEDS and recursive automata approaches. We conclude by detailing the visual processing involved and some results.

# 2 Objectives and Questions

The objective of this research project is to explore the basis for a consistent software and hardware environment, and a flexible system that is capable of performing a variety of inspection and reverse engineering activities. In particular, we will concentrate on the adaptive automatic extraction of some properties of the world to be sensed and on the subsequent use of the sensed data for producing reliable descriptions of the sensed environments for manufacturing and/or description refinement purposes. We use an observer agent with some sensing capabilities (vision and touch) to actively gather data (measurements) of mechanical parts.

Our thesis is that :

- Discrete Event Dynamical Systems (DEDS) provide the base for defining consistent and adaptive control structures for the inspection and reverse engineering problem.

If this is true, then we will be able to answer the following questions :

- What is a suitable algorithm to coordinate sensing, inspection, design and manufacturing ?
- What is a suitable control strategy for sensing the mechanical part ?
- Which parts should be implemented in hardware vs. software ?
- What are suitable language tools for constructing a reverse engineering and/or inspection strategy ?

We describe DEDS in more detail later, but they can be simply described as :

Dynamic systems (typically asynchronous) in which state transitions are triggered by discrete events in the system.

It is possible to *control* and *observe* hybrid systems (systems that involve continuous, discrete and symbolic parameters) under uncertainty using DEDS formulations [11,13].

The applications of this work are numerous : e.g., automatic inspection of mechanical or electronic components and reproduction of mechanical parts. Moreover, the experience gained in performing this research will allow us to study the subdivision of the solution into reliable, reversible, and an easy-to-modify software and hardware environments.

### 3 Methodology for Inspection

In this section we describe the solution methodology and discuss the components separately. The control flow is also described and the methods, specific equipment and procedures to be designed and implemented are also discussed in detail.

We use a vision sensor (B/W CCD camera) and a coordinate measuring machine (CMM) with the necessary software interfaces to a Sun Sparcstation as the sensing devices. The object is to inspected by the co-operation of the observer camera and the probing CMM, a DEDS is used as the high-level framework for exploring the mechanical part. Dynamic recursive finite state machines (DRFSM) are used to exploit the recursive nature of the parts under consideration. We next discuss DEDS in general and the recursive DRFSM implementation of DEDS, then we proceed to apply the framework for the inspection process.

#### 3.1 Discrete Event Dynamic Systems

Discrete event dynamic systems are dynamic systems (typically asynchronous) in which state transitions are triggered by the occurrence of discrete events in the system. DEDS are usually modeled by finite state automata with partially observable events together with a mechanism for enabling and disabling a subset of state transitions [2,10,11]. We propose that this model is a suitable framework for many reverse engineering tasks. In particular, we use the model as a high-level structuring technique for our system.

We can represent a DEDS by the following quadruple:

$$G = (X, \Sigma, U, \Gamma)$$

where  $X$  is the finite set of states,  $\Sigma$  is the finite set of possible events,  $U$  is the set of admissible control inputs consisting of a specified collection of subsets of  $\Sigma$ , corresponding to the choices of sets of controllable events that can be enabled and  $\Gamma \subseteq \Sigma$  is the set of observable events.

We can visualize the concept of DEDS by means of the example in Figure 1. The graphical representation is quite similar to a classical finite automaton. Here, circles denote states, and events are represented by arcs. The first symbol in each arc label denotes the event, while the symbol following “/” denotes the corresponding output (if the event is observable). Finally, we mark the controllable events by “:u”. Thus, in this example,  $X = \{0, 1, 2, 3\}$ ,  $\Sigma = \{\alpha, \beta, \delta\}$ ,  $\Gamma = \{\alpha, \delta\}$ , and  $\delta$  is controllable at state 3 but not at state 1.

An *alive* state is a state that can never undergo transitions leading to a state that has no outgoing transitions (a *dead* state). A system  $A$  is *alive* if all its states are *alive*. Stability can be defined with respect to the states of a DEDS automaton. Assuming that we have identified the set of “good” states,  $E$ , that we would like our DEDS to “stay within” or to not stay outside for an infinite time, then stabilizability can be formally defined as follows:

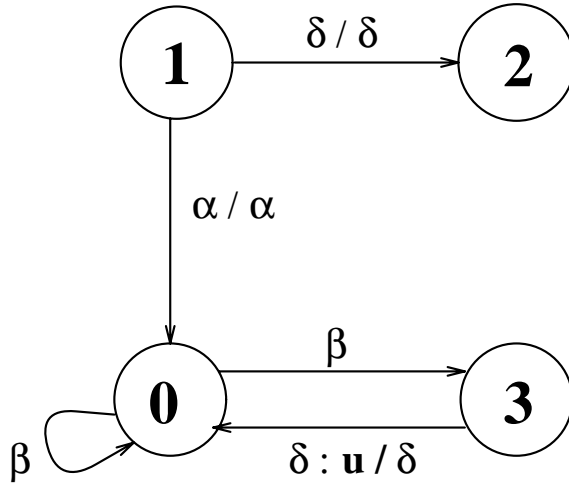

Figure 1: A Simple DEDS Example

Given a live system  $A$  and some  $E \subset X$ ,  $x \in X$  is *stabilizable* with respect to  $E$  (or  $E$ -stabilizable) if there exists a combination of controllable events (control pattern)  $K$  such that  $x$  is alive and does not stay outside  $E$  forever ( $E$ -stable) when  $K$  is used. A set of states,  $Q$ , is a *stabilizable set* if there exists a control pattern  $K$  so that every  $x \in Q$  is alive and stable in  $A_K$  ( $A$  under the control pattern  $K$ ), and  $A$  is a *stabilizable system* if  $X$  is a stabilizable set.

A DEDS is termed *observable* if we can use any sequence of observable events to determine the current state exactly at intermittent points in time separated by a bounded number of events. More formally, take any sufficiently long string,  $s$ , that can be generated from any initial state  $x$ . For any observable system, we can then find a prefix  $p$  of  $s$  such that  $p$  takes  $x$  to a unique state  $y$  and the length of the remaining suffix is bounded by some integer  $n_o$ . Also, for any other string  $t$ , from some initial state  $x'$ , such that  $t$  has the same output string as  $p$ , we require that  $t$  takes  $x'$  to the same, unique state  $y$ .

The basic idea behind strong output stabilizability is that we will know that the system is in state  $E$  iff the observer state is a subset of  $E$ . The compensator should then force the observer to a state corresponding to a subset of  $E$  at intervals of at most a finite integer  $i$  of observable transitions. If  $Z$  is the set of states of the observer, then  $A$  is strongly output  $E$ -stabilizable if there exists a state feedback  $K$  for the observer  $O$  such that  $O_K$  is stable with respect to  $E_O = \{\hat{x} \in Z \mid \hat{x} \subset E\}$ .

We advocate an approach in which a stabilizable semi-autonomous visual sensing interface would be capable of making decisions about the *state* of the observed machine part and the probe. Thus providing both symbolic and parametric descriptions to the reverse engineering and/or inspection control module. The DEDS-based active sensing interface will be discussed in the following section.

### Modeling and Constructing an Observer

The tasks that the autonomous observer system executes can be modeled efficiently within a DEDS framework. We use the DEDS model as a high level structuring technique to preserve and make use of the

information we know about the way in which a mechanical part should be explored. The state and event description is associated with different visual cues, for example; appearance of objects, specific 3-D movements and structures, interaction between the touching probe and part, and occlusions. A DEDS observer serves as an intelligent sensing module that utilizes existing information about the tasks and the environment to make informed tracking and correction movements and autonomous decisions regarding the state of the system.

In order to know the current state of the exploration process we need to observe the sequence of events occurring in the system and make decisions regarding the state of the automaton. State ambiguities are allowed to occur, however, they are required to be resolvable after a bounded interval of events. The goal will be to make the system a strongly output stabilizable one and/or construct an observer to satisfy specific task-oriented visual requirements. Many 2-D visual cues for estimating 3-D world behavior can be used. Examples include; image motion, shadows, color and boundary information. The uncertainty in the sensor acquisition procedure and in the image processing mechanisms should be taken into consideration to compute the world uncertainty.

Foveal and peripheral vision strategies could be used for the autonomous “focusing” on relevant aspects of the scene. Pyramid vision approaches and logarithmic sensors could be used to reduce the dimensionality and computational complexity for the scene under consideration.

### **Error States and Sequences**

We can utilize the observer framework for recognizing error states and sequences. The idea behind this recognition task is to be able to report on *visually incorrect* sequences. In particular, if there is a pre-determined observer model of a particular inspection task under observation, then it would be useful to determine if something goes wrong with the exploration actions. The goal of this reporting procedure is to alert the an operator or autonomously supply feedback to the inspecting robot so that it could correct its actions. An example of errors in inspection is unexpected occlusions between the observer camera and the inspection environment, or probing the part in a manner that might break the probe. The correct sequences of automata state transitions can be formulated as the set of strings that are *acceptable* by the observer automaton. This set of strings represents precisely the language describing all possible visual task evolution steps.

### **Hierarchical Representation**

Figure 2 shows a hierarchy of three submodels. Motives behind establishing hierarchies in the DEDS modeling of different exploration tasks includes reducing the search space of the observer and exhibiting modularity in the controller design. This is done through the designer, who subdivides the task space of the exploring robot into separate submodels that are inherently independent. Key events cause the transfer of the observer control to new submodels within the hierarchical description. Transfer of control through the observer hierarchy of models allows coarse to fine shift of attention in recovering events and asserting state transitions.

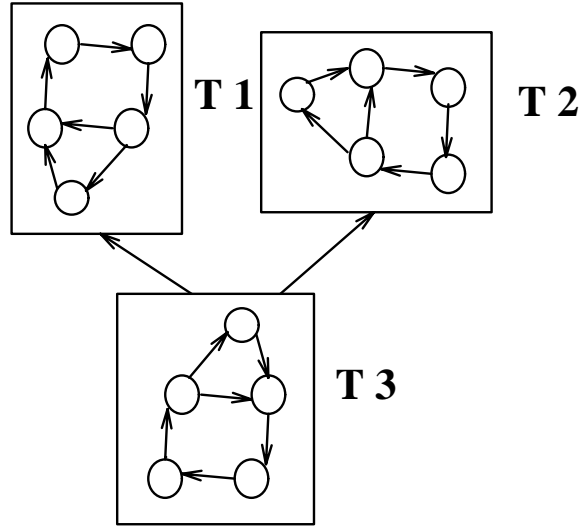

Figure 2: A Hierarchy of Tasks.

### Mapping Module

The object of having a mapping module is to dispense with the need for the manual design of DEDS automaton for various platform tasks. In particular, we would like to have an off line module which is to be supplied with some symbolic description of the task under observation and whose output would be the code for a DEDS automata that is to be executed as the observer agent. A graphical representation of the mapping module is shown in Figure 3. The problem reduces to figuring out what is an appropriate form for the task description. The error state paradigm motivated regarding this problem as the inverse problem of determining acceptable languages for a specific DEDS observer automaton. In particular, we suggest a skeleton for the mapping module that transform a collection of input strings into an automaton model.

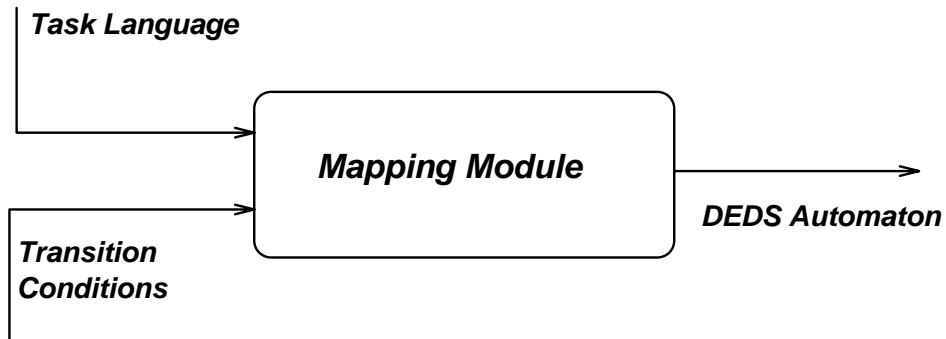

Figure 3: The Mapping Module.

The idea is to supply the mapping module with a collection of strings that represents possible state transition sequences. The input highly depends on the task under observation, what is considered as relevant states and how coarse the automaton should be. The sequences are input by an operator. It should be obvious that the “Garbage-in-garbage-out” principle holds for the construction process; in particular,

if the set of input strings is not representative of all possible scene evolutions, then the automaton would be a faulty one. The experience and knowledge that the operator have would influence the outcome of the resulting model. However, it should be noticed that the level of experience needed for providing these sets of strings is much lower than the level of experience needed for a designer to actually construct a DEDS automaton manually. The description of the events that cause transitions between different symbols in the set of strings should be supplied to the module in the form of a list.

As an illustrative example, suppose that the task under consideration is simple grasping of one object and that all we care to know is three configurations; whether the hand is alone in the scene, whether there is an object in addition to the hand and whether enclosure has occurred. If we represent the configurations by three states  $h$ ,  $h_o$  and  $h_c$ , then the operator would have to supply the mapping module with a list of strings in a language, whose alphabet consists of those three symbols, and those strings should span the entire language, so that the resulting automaton would accept all possible configuration sequences. The mapping from a set of strings in a regular language into a minimal equivalent automaton is a solved problem in automata theory.

One possible language to describe this simple automaton is :

$$L = hh^*h_o h_o^*h_c h_c^*$$

and a corresponding DEDS automaton is shown in Figure 4.

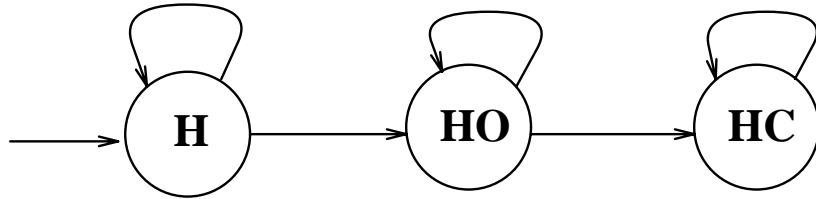

Figure 4: An Automaton for Simple Grasping.

The best-case scenario would have been for the operator to supply exactly the language  $L$  to the mapping module with the appropriate event definitions. However, it could be the case that the set of strings that the operator supplies do not represent the task language correctly, and in that case some learning techniques would have to be implemented which, in effect, augment the input set of strings into a language that satisfies some pre-determined criteria. For example,  $y^*$  is substituted for any string of  $y$ 's having a length greater than  $n$ , and so on. In that case the resulting automaton would be correct up to a certain degree, depending on the operator's experience and the correctness of the learning strategy.

### 3.2 Sensing Strategy

We use a B/W CCD camera mounted on a tripod, and a coordinate measuring machine (CMM) to sense the mechanical part. A DRFSM implementation of a discrete event dynamic system (DEDS) algorithm is used to facilitate the state recovery of the inspection process. DEDS are suitable for modeling robotic observers as they provide a means for tracking the *continuous*, *discrete* and *symbolic* aspects of the scene under consideration [2,10,11]. Thus the DEDS controller will be able to *model* and *report* the state evolution of the inspection process.

In inspection, the DEDS guides the sensing machines to the parts of the objects where discrepancies occur between the real object (or a CAD model of it) and the recovered structure data points and/or parameters. The DEDS formulation also compensates for noise in the sensor readings (both ambiguities and uncertainties) using a probabilistic approach for computing the 3-D world parameters [13]. The recovered data from the sensing module is then used to drive the CAD module. The DEDS sensing agent is thus used to collect data of a *passive* element for designing *structures*; an exciting extension is to use a similar DEDS observer for moving agents and subsequently design *behaviors* through a learning stage.

### 3.3 Dynamic Recursive Finite State Machines

Dynamic Recursive Finite State Machines (DRFSM) are a new methodology to represent and implement multi-level recursive processes using systematic implementation techniques. By multi-level process we mean any processing operations that are done repetitively with different parameters. (DRFSM) has proved to be a very efficient way to solve many complicated problems in the inspection paradigm using an easy notation and a straight forward implementation, specially for objects that has similar multi-level structures with different parameters. The main idea of the (DRFSM) is to reuse the conventional DEDS Finite State Machine for a new level after changing some of the transition parameters. After exploring this level, it will retain its old parameters and continue exploring the previous levels. Also, the implementation of such machines can be generated automatically by some modification to an existing reactive behavior design tool called (GIJOE) [3], that is capable of producing code from state machine descriptions (drawings), by adding a recursive representation to the conventional representation of finite state machines, and then generate the appropriate code for it.

#### 3.3.1 Definitions

- **Variable Transition Value:** If the transition condition from state to state contains some variable values that depends on the level of recursion, then this value is called Variable Transition Variable
- **Variable Transition Vector:** Is the vector containing all variable transitions values, and is dynamically changed from level to level.
- **Recursive State:** Is the state calling another state recursively, and this state is responsible for changing the variable transition vector to its new value according to the new level.
- **Dead-End State:** it is the state that does not call any other state (no transition arrows comes out of it). In DRFSM, when this state is reached, that means to go back to a previous level, or quit if it was the first level. This state is usually called Error-trapping state. It is desirable to have several dead-end states to represent different types of errors that could happen in the system.

#### 3.3.2 DRFSM Representation

We will use the same notations and terms of the ordinary FSM's, but some new notations will be added to represent recursive states and variable transitions. First, we will add a new type of transition arrows, as shown in Figure 5, this is called the Recursive Transition Arrow (RTA). A recursive transition arrow from one state to another means that the transition from the first state to the second state is done by



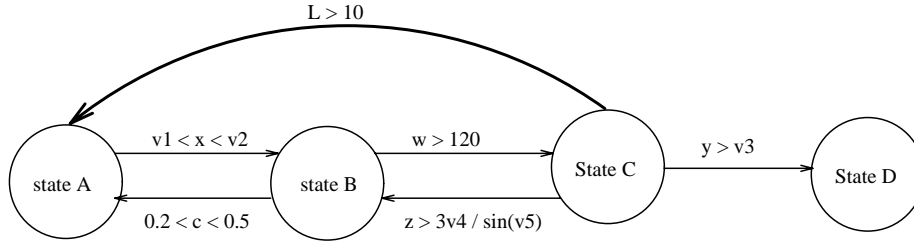

trans. Variables	V1	V2	V3	V4	V5
Level 1	12	15	0.03	170	25
Level 2	10	12	0.07	100	35
Level 3	6	8	0.15	50	40

Figure 5: A Simple DRFSM

a recursive call to the second one after changing the Variable Transition Vector. Second, the transition condition from a state to another may contain variable parameters according to the current level. These variable parameters will be distinguished from the constant parameters by the notation  $V(\text{parameter name})$ . All variable parameters of all state transitions will constitute the Variable Transition Vector. Figure 6 is the equivalent FSM representation (or the flat representation) of the DRFSM shown in Figure 5, and it illustrates the compactness and efficiency of the new notations for this type of processes. In many cases, however, it is impossible to build the equivalent FSM for a process that has some values of its Variable Transition Vector undefined until their corresponding level is reached. In these cases DRFSM's are the most appropriate way to deal with such applications.

### 3.3.3 Implementation of DRFSM

There is a software tool for designing reactive behaviors called GIJOE [2] which was developed recently in the Computer Science Department, it facilitate drawing any FSM, then it generates the required C code for this machine. And since we are going to use the same notations and terms of FSM's, it is convenient to modify this package by adding some facilities to allow drawing of DRFSM's and to generate the appropriate C code with a recursive call to some states with variable transition conditions. The required modifications will be accomplished in two phases:

- Drawing Phase.
- Code Generation Phase.

In the drawing phase a new arrow will be added (RTA) to represent a recursive call to any state. Also a notation for variable transition value will be added as shown in Figure 7

In the code generation phase, it is very important to preserve backward compatibility, fortunately, that is easy since we can check for the existence of RTA's. So, if no RTA is found, then it is a FSM and the

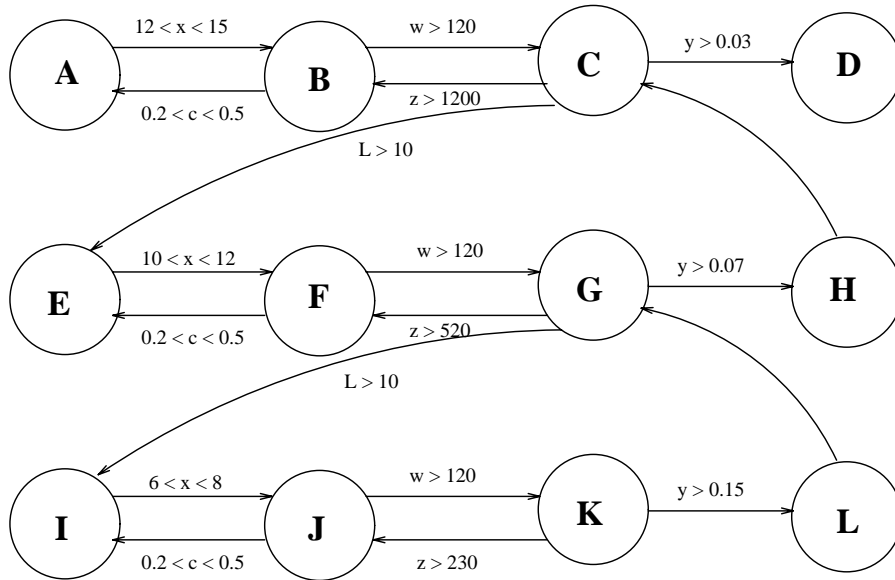

Figure 6: Flat Representation of a Simple DRFSM

**VTV : (v1, v2, v3, v4, v5)**

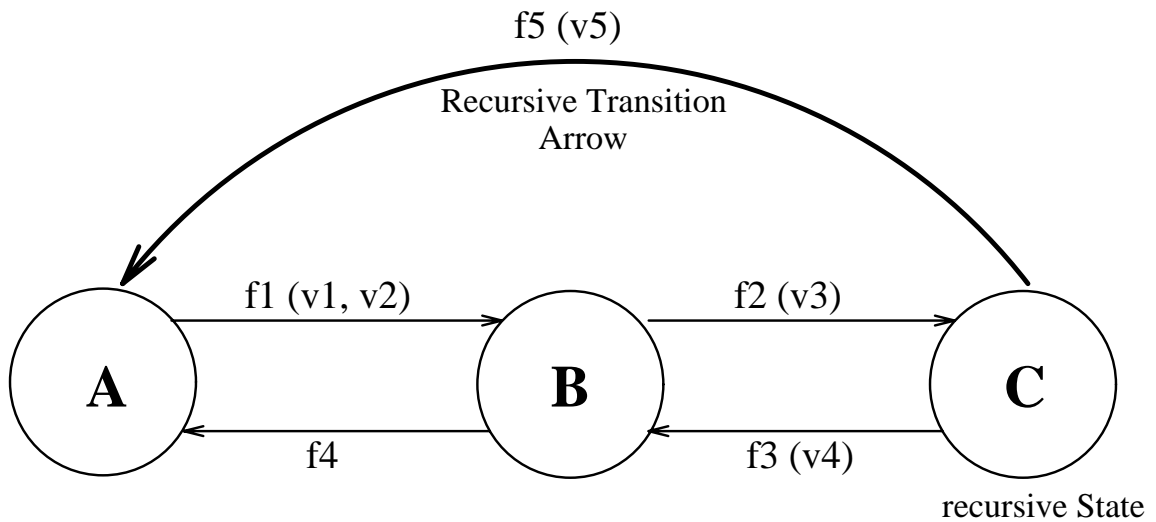

Figure 7: New Notation for GIJOE

code generated for this machine will be the same as before. On the other hand, if any RTA is found, then the following steps are required:

- Collect all variable transitions to form the VTV.
- For each RTA in the figure build a user-defined function called `Get_New_VTV` to be filled by the user of GIJOE later, since this function is very application dependent, then its purpose is to get the values of the new vector to be used in the new level of recursion, and it will be called from the recursive state.
- All states' functions will have a parameter which is the VTV.

With these modifications backward compatibility is guaranteed and the implementation of any DRFSM is easily maintained. In Appendix A, a generated code for the DRFSM is shown.

It should be clear, however, that the code generated by GIJOE is only a skeleton for the machine, and has to be filled out by the users according to the tasks assigned to each states.

### 3.3.4 How to use DRFSM ?

To apply DRFSM for any problem the following steps are required:

- Problem Analysis: Divide the problem into states, so that each state accomplish a simple task.
- Transition Conditions: Find the transition conditions between the states.
- Explore the repetitive part in the problem (recursive property) and Specify the recursive states. Some problems however may not have this property. In those cases a FSM is a better solution.
- VTV formation : If there are different transitions values for each level; these variables have to be defined.
- Error trapping : Using robust analysis, a set of possible errors can be established, then one or more Dead-End state(s) are added.
- DRFSM Design : Using GIJOE to draw the DRFSM and generate the corresponding C code.
- Implementation : The code generated by GIJOE has to be filled out with the exact task of each state, the error handling routines should be written, and the required output has to be implemented as well.

### 3.3.5 Applying DRFSM in Features extraction

An experiment was performed for inspecting a mechanical part using a camera and the coordinate measuring machine. A predefined DRFSM state machine was used as the observer agent skeleton. The camera was placed on a stationary tripod at the base of the table so that the part was always in view. The probe could then extend into the field of view and come into contact with the part, as shown in Figure 13.

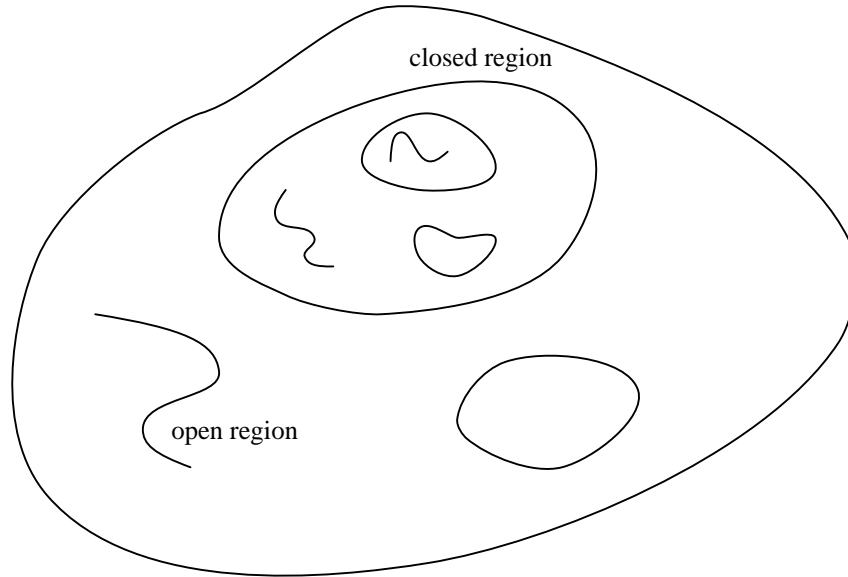

Figure 8: An Example for a Recursive Object

Symbolic Representation of Features: For this problem we are concerned with Open regions (O) and Closed regions (C). Any closed region may contain other features (the recursive property). Using Parenthesis notation the syntax for representing features can be written as follow:

$\langle \text{feature} \rangle :: C(\langle \text{subfeature} \rangle) \mid C()$   
 $\langle \text{subfeature} \rangle :: \langle \text{term} \rangle, \langle \text{subfeature} \rangle \mid \langle \text{term} \rangle$   
 $\langle \text{term} \rangle :: O \mid \langle \text{feature} \rangle$

For example, the symbolic notation of Figure 8 is

$$C(O, C((C(O, C()), O)), C())$$

Figure 9 shows the graphical representation of this recursive structure which is a tree-like structure. Future modifications to DRFSM's includes allowing different functions for each level.

The Figure 10 shows a simple DRFSM DEDS machine for the exploration and inspection of mechanical parts, using both active vision and touch sensors. Further experiments will be detailed in future technical reports.

## 4 Visual Processing

In order for the state machine to work, it must be aware of state changes in the system. As inspection takes place, the camera supplies images that are interpreted by a vision processor and used to drive the DRFSM.

The vision processor provides two separate pieces of information that are required by the machine, intrinsic information about the part to be inspected, and state information as the inspection takes place.

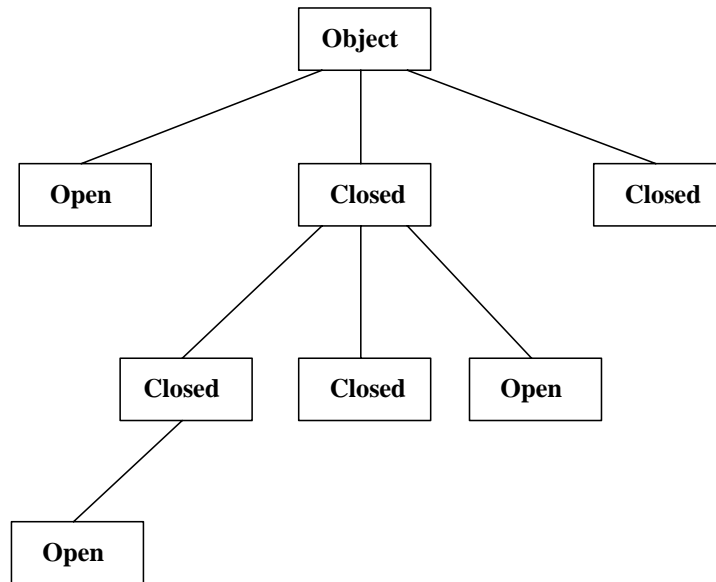

Figure 9: Graph for the Recursive Object

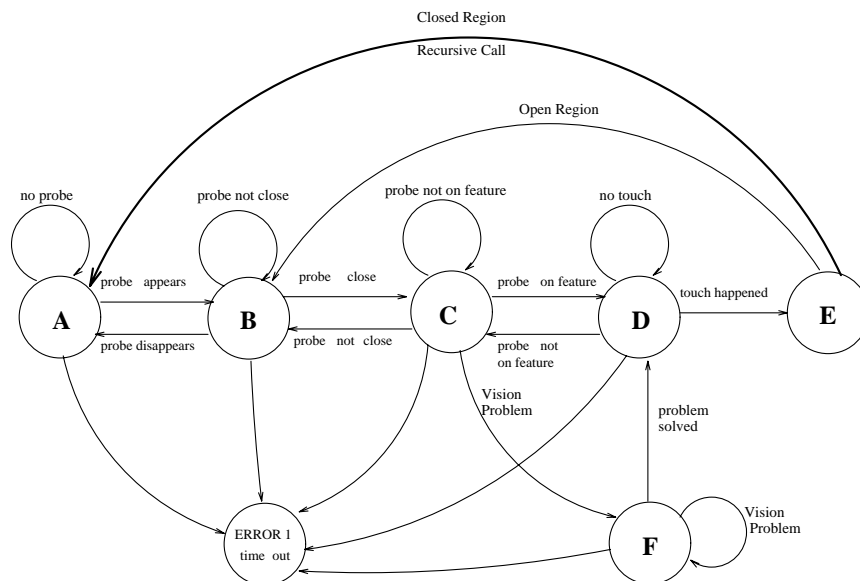

Figure 10: A DRFSM DEDS for Inspection

## 4.1 Extracting Feature Information

The state machine requires information about the 2-D features on the part to be inspected. We divide 2-D features into two categories, *open features* and *closed features*. An open feature is considered to be an edge that, when followed, has no closure. Closed features have the property that, through an edge pixel search, we are able to complete a closed loop.

After digitizing an image of the part, edge responses are captured using the zero-crossing technique. Next, we search the edge responses for the feature type that they represent. Using a recursive search and the orientation information given by the zero-crossing algorithm, we are able to label each edge as part of a closed feature or open feature.

## 4.2 Deciding Feature Relationships

Once we have found all of the features, we now search for the relationships between them. In the final representation of intrinsic information about the part, it is important to know which feature lies “within” another closed feature.

Consider a scene with two features, a part with an external boundary and a single hole. We would like to represent this scene with the string: “C(C())”. This can be interpreted as, a closed region within another closed region.

To discover if feature  $F_2$  is contained within  $F_1$  given that we know  $F_1$  is a closed feature, we select a point  $(x_2, y_2)$  on  $F_2$  and another point  $(x_1, y_1)$  on  $F_1$ . Now, we project the ray that begins at  $(x_2, y_2)$  and passes through  $(x_1, y_1)$ . We count the number of times that this ray intersects with  $F_1$ . If this is odd then we can say  $F_2$  is contained within  $F_1$  otherwise it must lie outside of  $F_1$ . (See Figures 11 and 12)

This algorithm will hold true as long as the ray is not tangential at the point  $(x_1, y_1)$  of feature  $F_1$ . To avoid this case, we simply generate two rays that pass through  $(x_2, y_2)$  and a neighboring pixel on  $F_1$ . If either of these have an odd number of intersections then  $F_2$  is contained in feature  $F_1$ . Knowing what features are present in the part and their relationships with each other will allow us to report the information in a string that is sent to the state machine. This process will be explained in detail in the next section.

## 4.3 Visual Observation of States

The visual processor supplies the proper input signals to the DRFSM DEDS as the inspection takes place. These signals are dependent upon the state of the scene and are triggered by discrete events that are observed by the camera.

The visual processor layer is made up of several filters that are applied to each image as it is captured. Several things must be known about the scene before a signal is produced. The location of the part, the location of the probe, the distance between them, the number of features on the part, and the distance to the closest feature.

First, the image is thresholded at a gray-level that optimizes the loss of background while retaining the part and probe. Next, a median filter is applied that removes small regions of noise. The image is then

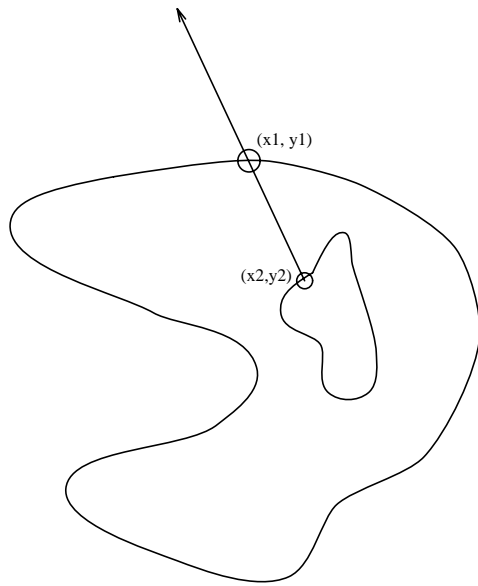

Figure 11: A closed region within another

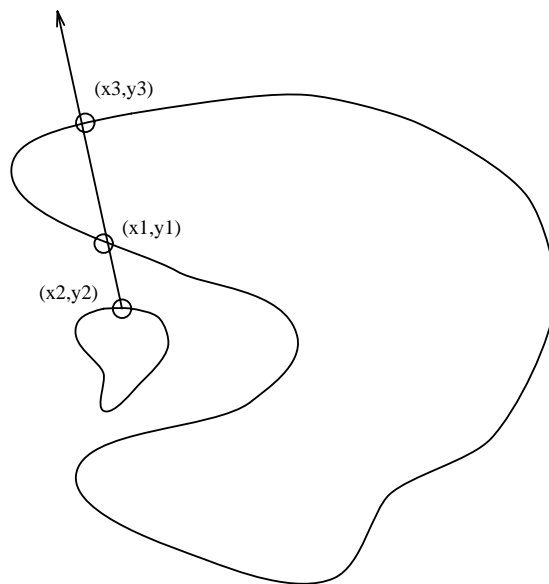

Figure 12: A closed region outside another



Figure 13: Experimental Setup

parsed to find all segments separated by an appropriate distances and labels them with a unique region identifier.

We are able to assume that the probe, if in the scene, will always intersect the image border. The probe tip is the farthest point on the probe region from the border. This holds true because of the geometry of the probe. An image with one region, that intersects the border, is the case in which the probe is touching the part.

If we have more than one region, we must discover the distance between the tip of the probe region and the part. This is done through an edge following algorithm that gives us the  $x, y$  positions of the pixels on the edge of each region. We then find the Euclidean distances between the edge points and the probe tip. The closest point found is used in producing the signal to the state machine.

Once this information is known, we are able to supply the correct signal that will drive the DRFSM DEFS. The machine, will then switch states appropriately and wait for the next valid signal. This process is a recursive one, in that, the machine will be applied recursively to the closed features. As the probe enters a closed region, another machine will be activated, that will inspect the smaller closed region with the same strategy that was used on the enclosing region.

## 5 Experiment

An experiment was performed that integrated the visual system with the state machine. An appropriate DRFSM was generated by observing the part and generating the feature information. A mechanical part was put on a black velvet background on top of the coordinate measuring machine table to simplify the vision algorithms. The camera was placed on a stationary tripod at the base of the table so that the part was always in view. The probe could then extend into the field of view and come into contact with the part, as shown in Figure 13.

Once the first level of the DRFSM was created, the experiment could proceed as follows. First, an



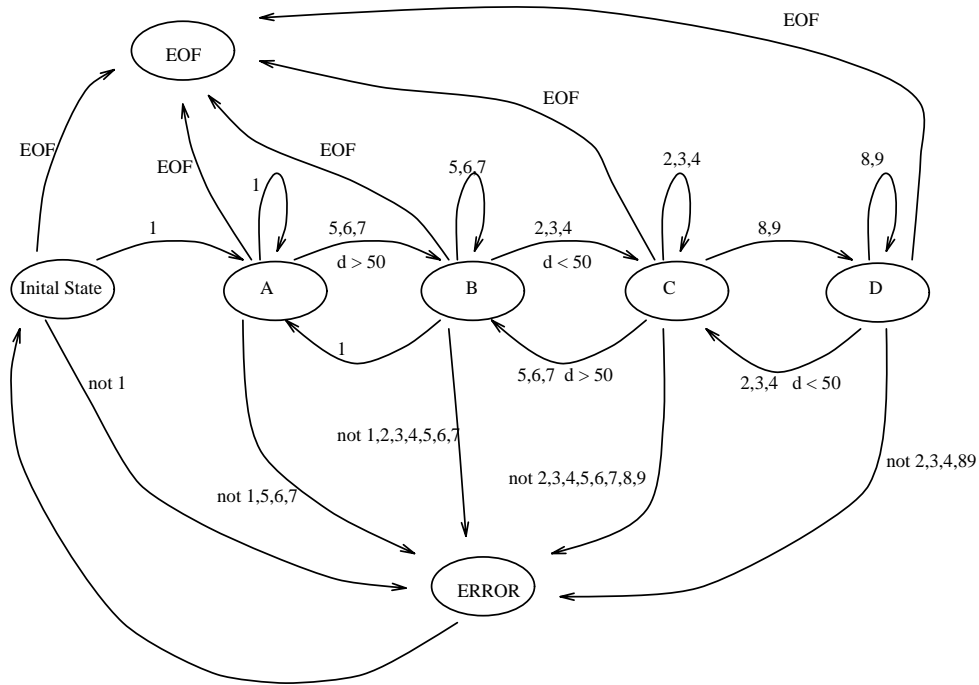

Figure 14: State Machine Used in Test

image was captured from the camera. Next, the appropriate image processing takes place to find the position of the part, the number of features observed (and the recursive string), and the location of the probe. A program using this information produces a state signal that is appropriate for the scene. The signal is read by the state machine and the next state is produced and reported. Each closed feature is treated as a recursive problem, as the probe enters a closed region, a new level of the DRFSM is generated with a new transition vector. This new level then drives the inspection for the current closed region.

### 5.1 DRFSM DEDS example

The specific dynamic recursive DEDS automata generated for the test was a state machine  $G$ . Where  $X = \{\text{Initial}, \text{EOF}, \text{Error}, \text{A}, \text{B}, \text{C}, \text{D}\}$  and  $\Sigma = \{1, 2, 3, 4, 5, 6, 7, 8, 9, \text{eof}\}$ . The state transitions were controlled by the input signals supplied by intermediate vision programs. There are four stable states A, B, C, and D that describe the state of the probe and part in the scene. The three other states, Initial, Error, and EOF specify the actual state of the system in special cases. The states can be interpreted as:

- Initial State: Waiting for first input signal
- A: Part Alone in Scene
- B: Probe and Part in Scene, probe is far from part.
- C: Probe and Part in Scene, probe is close to part.
- D: Probe touching or overlapping part. (recursive state)

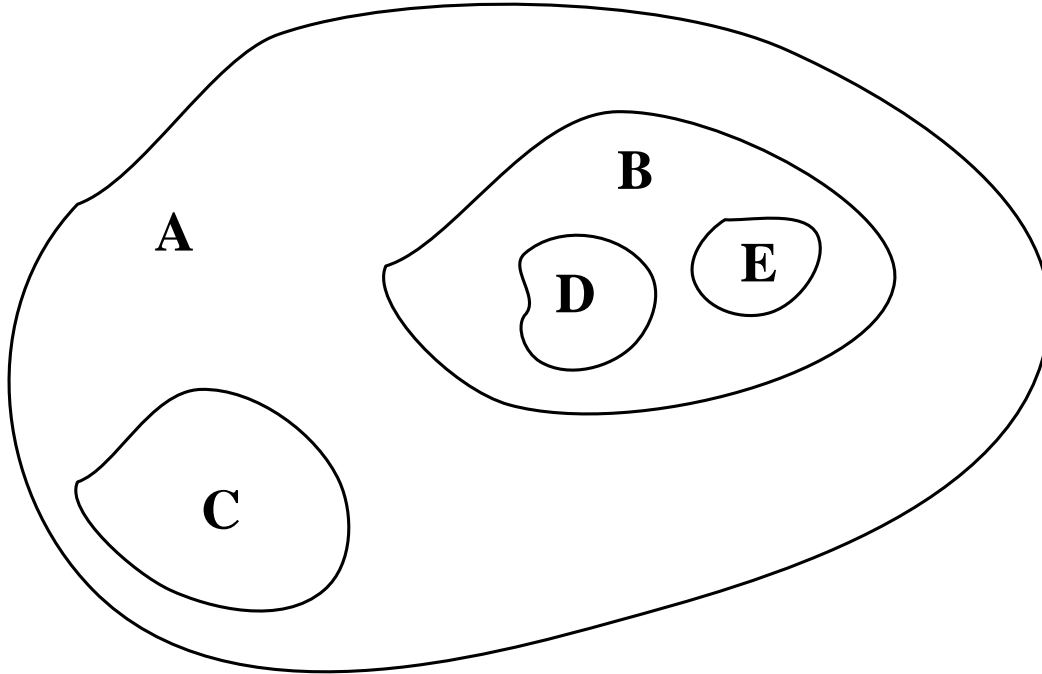

Figure 15: A Hierarchy Example

- Error: An invalid signal was received.
- EOF: The End of File signal was received.

## 5.2 Results

Two typical sequences from a probing task were run. In the first sequence, the probe was introduced into the scene and moved in a legal way (accepted by stable states in the machine) towards the part until contact was made. Next, the probe backed off and again approached until the probe and part overlapped. The automaton was forced into an error state by approaching from the other side of the part much too fast. The probe was not seen until it was too close to the object body. Because a transition from state A to C is invalid, and error state is reached. The part used was a simple one with only one hole, that is, it is represented by :  $C(C())$ .

Another sequence was tried out, the part was more complex, the representation was recovered to be the following string :  $C(C(),C(C()),C())$ . The probe was introduced into the scene and moved legally towards the part. Next, the probe backed off and again approached until the probe and the part overlapped. The automaton was forced into an error state by the sudden disappearance of the probe after it was very close to the part. Because a transition from state C to state A is invalid, an error state is reported. Each image was displayed on a terminal window as it was captured along with the corresponding state of the automaton. The same state representations are displayed for different layers in the DRFSM (i.e, for different features).



01-020-01 - Photo - Hole - In - Square

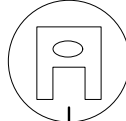

01-020-01 - Photo - Approaching Object

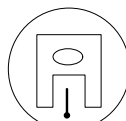

01-020-01 - Photo - Close - To - Object

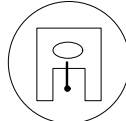

00120 © Peter Tunney/Alamy

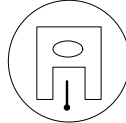

00120 © Peter Tunney/Alamy

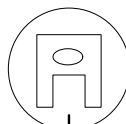

00120 © Peter Tunney/Alamy

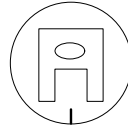

01-028 B. Public Approaching Object

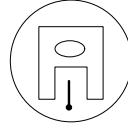

01-028 C. Public Clear To Object

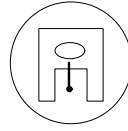

01-028 D. Public Tracking Object

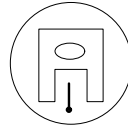

01-028 E. Public Clear To Object

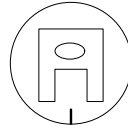
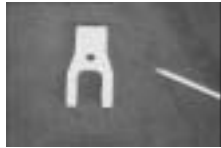

01-028 B. Public Approaching Object

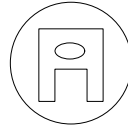

01-028 A. Public Not In Alarm

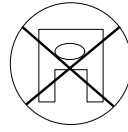

01-028 F. Alarm

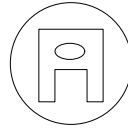

01-028 A. Public Not In Alarm

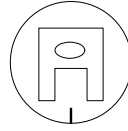

01-028 B. Public Approaching Object

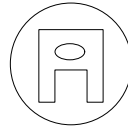

01-028 A. Public Not In Alarm

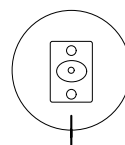
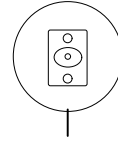
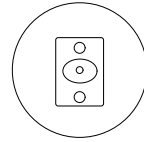

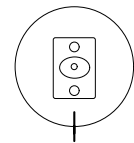
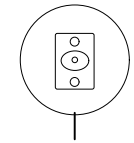
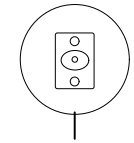
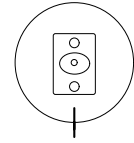
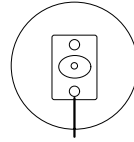
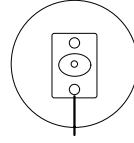

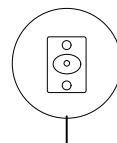
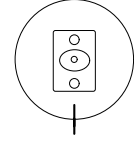
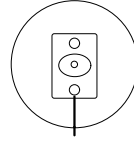



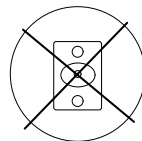
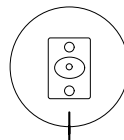
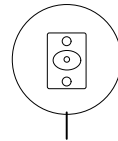
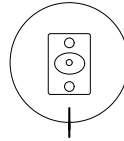
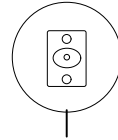
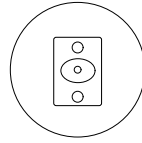

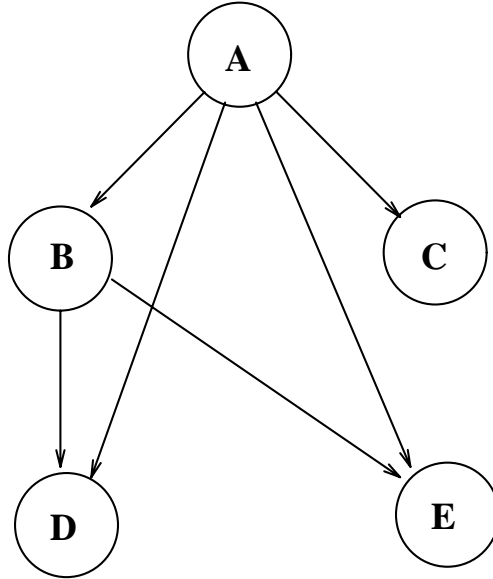

Figure 16: The graph associated with the example

## 6 Constructing the Recursive Relation

One of the problems we have encountered in this experiment was converting the set of relations between closed regions to the proposed syntax for describing objects. For example, the syntax of Figure 15 is:

$$C(C(C()),C()),C())$$

and the relations generated by the image processing program are:

$$B \in A \longrightarrow (1)$$

$$C \in A \longrightarrow (2)$$

$$D \in B \longrightarrow (3)$$

$$D \in A \longrightarrow (4)$$

$$E \in B \longrightarrow (5)$$

$$E \in A \longrightarrow (6)$$

These relations can be represented by a graph as shown in Figure 16. the target is to convert this graph to an equivalent tree structure, which is the most convenient data structure to represent our syntax.

As a first attempt, we have designed an algorithm to convert from graph representation to tree representation by scanning all possible paths in the graph and putting weights to each node according to number of visits to this node. In other words, update the depth variable of each node by traversing the tree in all possible ways and then assigning the nodes the maximum depth registered from a traversal, and propagating that depth downwards. Then from these depth weights we can remove the unnecessary arcs from the graph by keeping only the arcs that has a relation between a father of *maximum* depth and a

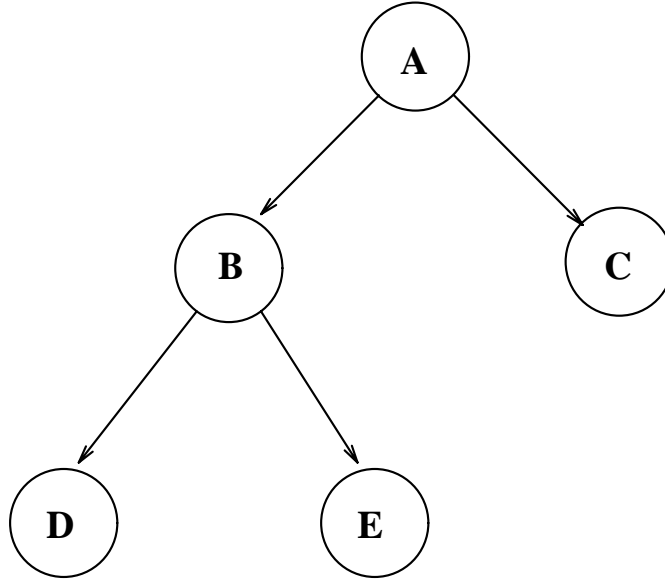

Figure 17: The tree associated with the example

son, and eliminating all other father arcs, thus yielding the required tree (Figure 17). The complexity of this algorithm was  $O(n \log n)$ .

However, we have developed a better algorithm that scans the relations, count the number of occurrences for each closed region name mentioned in the left side of the relations giving an array  $RANK(x)$ , where  $x \in \{A,B,C,\dots\}$ , and select the relations  $(x_1 \in x_2)$  that satisfies the following condition:

$$RANK(x_1) - RANK(x_2) = 1$$

This guarantees that all redundant relations won't be selected. the complexity of this algorithm is  $O(n)$ . Applying this algorithm to the relations of Figure 15 we have,

$$\begin{aligned} RANK(A) &= 0 \\ RANK(B) &= 1 \\ RANK(C) &= 1 \\ RANK(D) &= 2 \\ RANK(E) &= 2 \end{aligned}$$

The selected relations will be:

$$\begin{aligned} B &\in A \\ C &\in A \\ D &\in B \\ E &\in B \end{aligned}$$

Now arranging these relation to construct the syntax gives:

$$A(B()) \longrightarrow A(B(),C()) \longrightarrow A(B(D()), C()) \longrightarrow A(B(D(),E()),C())$$

which is the required syntax. A tree representing this syntax is easily constructed and shown in Figure 17. The next step would be to insert the open regions, if any, and this is done by traversing the

tree from the maximum depth and upwards. Any open region can be tested by checking any point in it and checking whether it lies within the maximum depth leaves of the closed regions' tree hierarchy (The test is easily done by extending a line and checking how many times it intersects a closed region, as in the test for closed regions enclosures). Then the upper levels of the hierarchy are tested in ascending order till the root is reached or all open regions have been exhausted. Any open region found to be inside a closed one while traversing the tree is inserted in the tree as a son for that closed region. It should be noticed that this algorithm is *not* a general graph  $\rightarrow$  tree conversion algorithm, it only works on the specific kind of graphs that the image processing module recovers. That is, the conversion algorithm is *tailored* to the visual recursion paradigm.

## 7 Current Developments

The application environment we eventually intend to develop consists of three major working elements: the sensing, design, and manufacturing modules. The ultimate goal is to establish a computational framework that is capable of deriving designs for machine parts or objects, inspect and refine them, while creating a flexible and consistent engineering environment that is extensible. The control flow is from the sensing module to the design module and then to the manufacturing component. Feedback can be re-supplied to the sensing agent to inspect manufactured parts, compare them to the originals and continue the flow in the loop until a certain tolerance is met. The system is intended to be ultimately as autonomous as possible. We intend to study what parts of the system can be implemented in hardware. Some parts seem to be inherently suited to hardware, which will be discussed later, some other parts of the system may be possible to put in hardware, but experimentation will provide the basis for making that decision. Providing language interfaces between the different components in the inspection and reverse engineering control loop is an integral part of the project.

### 7.1 Robotics and Sensing

We intend to use a robot arm (a PUMA 560), a vision sensor (B/W CCD camera) mounted on the end effector and a coordinate measuring machine (CMM). A discrete event dynamic system (DEDS) algorithm will be used to coordinate the movement of the robot sensor and the CMM. The DEDS control algorithm will also guide the CMM to the relevant parts of the objects that need to be explored in more detail (curves, holes, complex structures, etc.)

### 7.2 Computer Aided Design and Manufacturing

The data and parameters derived from the sensing agent are then to be fed into the CAD system for designing the geometry of the part(s) under inspection. We intend to use the  $\alpha_1$  design environment [12,15] for that purpose. The goal is to provide automatic programming interfaces from the data obtained in the sensing module to the  $\alpha_1$  programming environment. The parametric and 3-D point descriptions are to be integrated to provide consistent and efficient surface descriptions for the CAD tool. For pure inspection purposes the computer aided geometric description of parts could be used as a *driver* for guiding both the robotic manipulator and the coordinate measuring machine for exploring the object and recognizing discrepancies between the real part and the model.

The computer aided design parameters are then to be used for manufacturing the prototypes. Considerable effort has been made for automatically moving from a computer aided geometric model to a process plan for making the parts on the appropriate NC machines and then to automatically generate the appropriate machine instructions [6]. We intend to use the Monarch VMC-45 milling machine as the manufacturing host. The  $\alpha_1$  system will produce the NC code for manufacturing the parts.

### 7.3 VLSI and Languages

The software and hardware requirements of the environment are the backbone for this project. We intend to select parts of the system implementation and study the possibility of hardwiring them. There has been considerable effort and experience in VLSI chip design [4,7] and one of the sub-problems would be to study the need and efficiency of making customized chips in the environment. The DEDS model, as an automaton, is very suitable for Path Programmable Logic (PPL) implementation. A number of the visual sensing algorithms could be successfully implemented in PPL, saving considerable computing time. Integrated circuits for CAGD surface manipulation is an effort that is already underway. We intend to investigate a new area: the possibility of implementing the DEDS part of the system in integrated circuitry.

There is a lot of interfacing involved in constructing the inspection and reverse engineering environments under consideration. Using multi-language object-based communication and control methodology between the three major components (Sensing, CAD and CAM) is essential. We intend to use a common shared database for storing data about the geometric model and the rules governing the interaction of the different phases in the reproduction and inspection paradigms [9,14]. We also intend to use a graphical behavior design tool [3] for the automatic production of the sensing DEDS automata code, from a given control language description.

## 8 Conclusions

We propose a new strategy for inspection and/or reverse engineering. We concentrate on the inspection of machine parts. We also describe a framework for constructing a full environment for generic inspection and reverse engineering. The problem is divided into *sensing*, *design*, and *manufacturing* components with an underlying software and hardware backbone. This project aims at developing control strategies for sensing the world and coordinating the different activities between the phases. We use a recursive DEDS DRFSM framework to construct an intelligent observer module for inspection. The developed framework utilizes existing knowledge to formulate an adaptive and goal-directed strategy for exploring mechanical parts.

## References

- [1] R. Bajcsy, "Active Perception," *Proceedings of the IEEE*, Vol. 76, No. 8, August 1988.
- [2] A. Benveniste and P. L. Guernic, "Hybrid Dynamical Systems Theory and the SIGNAL Language," *IEEE Transactions on Automatic Control*, Vol. 35, No. 5, May 1990.
- [3] M. J. Bradakis, "Reactive Behavior Design Tool," Master's Thesis, Computer Science Department, University of Utah, January 1992.

- [4] T. M. Carter, K. F. Smith, S. R. Jacobs, and R. M. Neff, "Cell Matrix Methodologies for Integrated Circuit Design," *Integration, The VLSI Journal*, 9(1), 1990.
- [5] F. Chaumette and P. Rives, "Vision-Based-Control for Robotic Tasks," In *Proceedings of the IEEE International Workshop on Intelligent Motion Control*, Vol. 2, pp. 395-400, August 1990.
- [6] S. Drake and S. Sela, "A Foundation for Features," *Mechanical Engineering*, 111(1), January 1989.
- [7] J. Gu and K. Smith, "A Structured Approach for VLSI Circuit Design," *IEEE Computer*, 22(11), 1989.
- [8] C. D. Hansen and T. C. Henderson, "CAGD-Based Computer Vision," *IEEE Transactions on Pattern Analysis and Machine Intelligence*, PAMI-11(10) : 1181-1193, 1989.
- [9] G. Lindstrom, J. Maluszynski, and T. Ogi, "Using Types to Interface Functional and Logic Programming," July 1990, 10 pp. technical summary submitted to 1991 SIGPLAN Symposium on Principles of Programming Languages.
- [10] A. Nerode and J. B. Remmel, "A Model for Hybrid Systems," Presented at the Hybrid Systems Workshop, Mathematical Sciences Institute, Cornell University, May 1991.
- [11] C. M. Özveren, *Analysis and Control of Discrete Event Dynamic Systems : A State Space Approach*, Ph.D. Thesis, Massachusetts Institute of Technology, August 1989.
- [12] R. F. Riesenfeld, "Mathematical Methods in Computer Aided Geometric Design," chapter Design Tools for Shaping Spline, Academic Press 1989.
- [13] T. M. Sobh and R. Bajcsy, "A Model for Observing a Moving Agent," *Proceedings of the Fourth International Workshop on Intelligent Robots and Systems (IROS '91)*, Osaka, Japan, November 1991.
- [14] M. Swanson, R. Kessler, "Domains : efficient mechanisms for specifying mutual exclusion and disciplined data sharing in concurrent scheme," *First U.S./Japan Workshop on Parallel*, August 1989.
- [15] J. A. Thingvold and E. Cohen, "Physical Modeling with B-Spline Surfaces for Interactive Design and Animation," *Proceedings of the 1990 Symposium on Interactive 3-D graphics*, ACM, March 1990.

## Appendix A

```
/* Code Generated for a Simple Dynamic Recursive Finite State Machine */

main()
{

    /* Some initializations */

    VTV_ptr = get_VTV() ;
    drfsm (VTV_ptr) ;

    /* Finish Up */

}

/*****/

drfsm (VTV_ptr)
{
    /* do some initializations for each level */

    state_A (VTV_ptr) ;

    /* do some cleaning */
}

/*****/

state_A (VTV_ptr)
{
    int finish = 0 ;

    /* do something */

    while ( !finish ){
        get-action1 (x) ;
        if ((x > VTV_ptr[1]) && (x < VTV_ptr[2])){
            finish = 1 ;
            state_B (VTV_ptr) ;
        }
    }
}
```

```

    }
  }
}

/*****/

state_B (VTV_ptr)
{
  int finish = 0 ;

  /* do something */

  while ( !finish ){
    get-action2 (c, w) ;
    if ((c > 0.2) && (c < 0.5)){
      finish = 1 ;
      state_A (VTV_ptr) ;
    }
    if (w > 120){
      finish = 1 ;
      state_C (VTV_ptr) ;
    }
  }
}

/*****/

state_C (VTV_ptr)
{
  int finish = 0 ;

  /* do something */

  while ( !finish ){
    get-action3 (L,z,y) ;
    if (z > 3*VTV_ptr[4]/sin(VTV_ptr[5])){
      finish = 1 ;
      state_B (VTV_ptr) ;
    }
    if (y > VTV_ptr[3]){
      finish = 1 ;
      state_D (VTV_ptr) ;
    }
  }
}

```



```

    }
    if (L > 10){
        newVTV_ptr = get_VTV() ;
        drfsm (new_VTV_ptr) ;
        /* Free memory allocated to new_VTV */
        /* Complete something */
    }
}

/*****/

state_D (VTV_ptr)
{

    /* do something */
    /* end of this level ... return to previous level */

}

/*****/

```